



**Beta**



***30% off list***  
**Promotion**  
**Valid until**  
**31/03/2018**

**Prices do not include V.A.T.**

# new item C33

## Mobile roller cab

- Four castors with steel cores, Ø 125 mm: 2 fixed and 2 steering (one with brake).
- Front centralized safety lock.



Convenient "V" groove for working pipes and sections.

Built-in side bottle and paper holders, adjustable in several position

Corner bumpers throughout height of roller cab, to avoid damaging vehicles in garage.

Sturdy multi-purpose worktop. Tote-trays and holes for accommodating screwdrivers.

**kg**  
**1000**



Pull-out drawer with quick release system made of fibreglass-reinforced nylon, opening throughout length of drawer.

n°	h	max
5	75 mm	30 kg
1	150 mm	35 kg
1	225 mm	35 kg

**71 kg**

033000271

033000272

033000273

~~£950,00~~ **£665,00**

## C33/6

Mobile roller cab with 6 drawers



n°	h	max
4	75 mm	30 kg
1	150 mm	35 kg
1	305 mm	35 kg

**69 kg**

033000261

033000262

033000263

~~£890,00~~ **£623,00**

## C33/8

Mobile roller cab with 8 drawers



n°	h	max
6	75 mm	30 kg
2	150 mm	35 kg

**73 kg**

033000281

033000282

033000283

~~£1,000,00~~ **£700,00**

# C24S

## Mobile roller cab

- Four castors with steel cores, Ø 125 mm: 2 fixed and 2 steering (one with brake).
- Front centralized safety lock.
- Can accommodate paper roll holder item 2400S-R/PC, to be ordered separately.



Sturdy ABS worktop.

**kg**  
**800**



Pull-out drawer with quick release system made of fibreglass-reinforced nylon, opening throughout length of drawer.

Built-in side bottle holder.

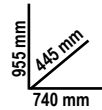

**58**  
**kg**

n°	h	max
5	70 mm	25 kg
1	140 mm	30 kg
1	210 mm	30 kg

024002071 024002072 024002073

~~£770,00~~ **£539,00**

## C24S/6

Mobile roller cab with 6 drawers



024002061 024002062 024002063

~~£750,00~~ **£525,00**

**55**  
**kg**

n°	h	max
4	70 mm	25 kg
1	140 mm	30 kg
1	280 mm	35 kg

## C24S/8

Mobile roller cab with 8 drawers



024002081 024002082 024002083

~~£840,00~~ **£567,00**

**61**  
**kg**

n°	h	max
6	70 mm	25 kg
2	140 mm	30 kg

# C35 *new item*

## Industrial tool chest

- With pull-out drawers 600x447 mm
- Front centralized safety lock.

**Kg**  
**1200**



## C35/7

**77**  
**kg**

n°	h	↓ max
2	75 mm	70 kg
1	100 mm	70 kg
3	150 mm	70 kg
1	200 mm	70 kg

035000072

~~£1,100,00~~ **£770,00**

## C35/6

### Industrial tool chest with 6 drawers

**73**  
**kg**

n°	h	↓ max
2	75 mm	70 kg
1	100 mm	70 kg
1	150 mm	70 kg
1	200 mm	70 kg
1	300 mm	70 kg

035000062

~~£1,060,00~~ **£742,00**

## C35/8

### Industrial tool chest with 8 drawers

**80**  
**kg**

n°	h	↓ max
4	75 mm	70 kg
1	100 mm	70 kg
2	150 mm	70 kg
1	200 mm	70 kg

035000082

~~£1,180,00~~ **£826,00**

## C35/9

### Industrial tool chest with 9 drawers

**84**  
**kg**

n°	h	↓ max
6	75 mm	70 kg
3	150 mm	70 kg

035000092

~~£1,240,00~~ **£868,00**

## 3500/P

### Worktop with external edge 717x600 mm



035000502

~~£81,50~~ **£57,00**

## C24SA-XL/7

### Mobile roller cab with anti-tilt system, long model

- Four castors with steel cores, Ø 125 mm: 2 fixed and 2 steering (one with brake).
- Front centralized lock.
- Can accommodate paper roll holder item 2400S-R/PC, to be ordered separately.

ABS worktop, with 6 tote-trays.

**kg**  
**1000**



Sturdy nylon front, with built-in label holder.

Built-in side bottle holder.



### Anti-tilt system



Can accommodate up to 6 thermoformed trays in one drawer

**84**  
**kg**

n°	h	max
5	75 mm	30 kg
1	140 mm	35 kg
1	210 mm	35 kg

024002271

024002272

024002273

~~£1,050,00~~ **£735,00**

## C24SA-XL/8

### Mobile roller cab with 8 drawers



024002281

024002282

024002283

~~£1,130,00~~ **£791,00**

**88**  
**kg**

n°	h	max
6	70 mm	30 kg
2	140 mm	35 kg

## C24SA-XL/9

### Mobile roller cab with 9 drawers



024002331

024002332

024002333

~~£1,180,00~~ **£811,00**

**92**  
**kg**

n°	h	max
8	70 mm	30 kg
1	140 mm	35 kg



# C51

## Trolley

- 3 tops covered in antislip ribbed rubber
- Two fixing options for central worktop
- Four castors Ø 100 mm:  
2 fixed and 2 steering (one with brake)

kg  
200



051000001 051000002 051000003

£246,00 £172,00

21 kg  
900 mm  
450 mm  
800 mm

## 2038/TV

*new item*

Tool trolley, made of thick polypropylene, empty

- Highly shock resistant
- Aluminium sealing profile
- Telescopic handle and big ball bearing castors
- Spacious bottom
- Document pocket
- 3 tote drawers

- 2 ergonomic rubber-coated handles (including 1 side handle)

- 2 removable tool panels.



- 2 TSA approved locks with keys

9 kg

430x500x340 mm

020380000

£755,00 £530,00

## 42/SP15

Set of 15 combination wrenches with holder

☎ 6-7-8-9-10-11-12-13-14-15  
16-17-19-22-24 mm



000420078

~~£149,00~~

£104,00

## 55/SP7

Set of 7 double open end wrenches with holder

☎ 6x7-8x9-10x11-12x13-14x15  
16x17-18x19 mm



000550167

~~£49,50~~

£35,00

## 42/SC9I

Set of 9 combination wrenches, open and offset ring ends, with compact support

☎ 8-10-11-12-13-14-15-17-19 mm



000420087

~~£89,50~~

£63,00

## 142/SC9I

Set of 9 reversible ratcheting combination wrenches, with compact support

☎ 8-10-11-12-13-14-15-17-19 mm



001420087

~~£185,00~~

£130,00

## 90/S7

Set of 7 double ended deep offset ring wrenches

6x7-8x9-10x11-12x13-14x15-16x17-18x19 mm



000900163

~~£71,50~~ **£45,00**

## 111

Adjustable wrenches with scales, chrome-plated

- Movable jaw opening with right-hand rotation of pin
- Head angled at 22.5 degrees, with mm and inch scale



*mm/inch readout*

	L mm	A max.		£
<b>111/100</b>	100	15 mm	001110010	<del>£17,50</del> <b>£12,00</b>
<b>111/150</b>	150	24 mm	001110015	<del>£18,00</del> <b>£13,00</b>
<b>111/200</b>	200	28 mm	001110020	<del>£23,00</del> <b>£16,00</b>
<b>111/250</b>	250	34 mm	001110025	<del>£29,00</del> <b>£20,00</b>
<b>111/300</b>	300	35 mm	001110030	<del>£36,50</del> <b>£26,00</b>

## 195/B5

Set of 5 ratcheting double-ended flat bi-hex ring wrenches in wallet

8x10-12x13-14x15-16x18-17x19 mm



001950066

~~£108,00~~ **£76,00**

## 88/S7

Set of 7 double ended flat ring wrenches, extra-long series

**EXTRA-LONG**



000880107

~~£162,00~~ **£113,00**

mm	L mm
8x10	235
12x14	330
13x15	330
16x18	405
17x19	405
21x23	435
22x24	435



# Male-end wrenches

## 933/S7

Set of 7 double ended offset hexagon socket wrenches

○ 8-10-11-12-13-17-19 mm

009330077

~~£80,50~~ £46,00



## 96T/S5P



Set of 5 offset hexagon key wrenches with handles

○ 2,5-3-4-5-6 mm

000960946

~~£52,50~~ £31,00



## 97TTX/S6



Set of 6 ball head offset key wrenches for Torx® head screws with handles

○ T10-T15-T20-T25-T30-T40

000970791

~~£76,50~~ £54,00



## 96/SC9



Set of 9 offset hexagon key wrenches

000960374

~~£16,50~~ £12,00



Ø mm	L mm
1,5	42
2	48
2,5	59
3	62
4	70
5	81
6	92
8	102
10	116

wrench locking system





## 1203/D8P

Set of 8 screwdrivers

1201 2,5x50-3x75-4x100-5,5x100-6,5x150 mm  
1202 PH0x60-PH1x80-PH2x100 mm

012030018

~~£31,50~~ £22,00



## 1203/D10N

Set of 10 screwdrivers

1201 2,5x50-3x75-4x100-5,5x150-6,5x150 mm  
1202 PH0x60-PH1x80-PH2x100 mm  
1201N 4x30 mm  
1202N PH1x30 mm

012030019

~~£41,00~~ £29,00



## 1207TX/D7

Set of 7 screwdrivers

1207TX T6-T8-T10-T15-T20-T25-T30

012070207

~~£37,50~~ £26,00

## 852 1/4



Bit holder with articulated T handle

*new item*

L 400 mm

008520006

~~£34,50~~ £24,00



*new item*



## 867/C20

Assortment of 18 bits for RIBE® screws, with 10 mm hexagon drive and 2 accessories, in soft foam tray and metal case

## Bits



	867/1		L 38 mm	○ 10 mm - □ 3/8
	867/2		L 38 mm	○ 10 mm - □ 1/2
	867RIBE	⊗	L 30 mm	5-6-7-8-9-10-11-12-13 mm
	867RIBE/L	⊗	L 75 mm	5-6-7-8-9-10-11-12-13 mm

008670920

~~£95,50~~ £57,00

335x145x60 mm

# Sockets

Can be extended by up to an additional 70% vs. standard

**920/55L**

**12"**

**72**

## Extension reversible ratchet

- 1/2" male drive
- 72 tooth mechanism

009200927

~~£101,00~~

**£71,00**



7 different lengths  
280 to 422 mm



**1/4"**

**3/8"**

**1/2"**

## Reversible ratchet with rotating handle

- Socket release button
- Ring nut reversal system on ratchet head
- Bi-material handle

Rotating the handle clockwise and anticlockwise will make the bit turn quickly



A mm

Ø mm

	L mm	Ø mm	A mm	■		£
<b>900/58</b>	126	28	28,5	1/4"	009000884	<del>£68,50</del> <b>£48,00</b>

**1/4"**

**3/8"**

**1/2"**

**3/4"**

## Reversible ratchet chrome-plated

A mm

Ø mm

	L mm	Ø mm	A mm	■		£
<b>900/55</b>	125	25	18	1/4"	009000870	<del>£41,50</del> <b>£29,00</b>
<b>910/55</b>	200	30	33	3/8"	009100882	<del>£49,50</del> <b>£35,00</b>
<b>920/55</b>	275	40	43	1/2"	009200882	<del>£63,00</del> <b>£44,00</b>
<b>928/55</b>	510	58	59	3/4"	009280862	<del>£155,00</del> <b>£108,50</b>

**1/4"**

**1/4"**

Assortment of 11 hexagon sockets, 21 bits and 7 accessories in plastic case

	861LP	●	0,6x4,5-1,2x6,5-1,2x8 mm
	861PE	○	2,5-3-4-5-6 mm
	861PH	⊕	PH1-PH2-PH3
	861PZ	⊕	PZ1-PZ2-PZ3
	861RTX	⊕	T10-T15-T20-T25-T27-T30-T40 mm
	892/0	●	1/4" - 1/4"
	895/1	○	1/4" - 1/4"
	900	○	5-5,5-6-7-8-9-10-11-12-13-14 mm
	900/20		50 mm
	900/20L		100 mm
	900/25		
	900BG/30C		

**900/C39-R**

reversible ratchet with rotating handle (900/58)

009000938

~~£184,00~~

**£110,00**



**12"**

Assortment of 17 hexagon sockets and 5 accessories in foam tray, in metal case

## 920A/C17M

reversible ratchet (920/55)

009200924

~~£276,00~~ **£174,00**

	920A	○	10-11-12-13-14-15-16-17-18-19 20-21-22-24-27-30-32 mm
	920/21		125 mm
	920/22		255 mm
	920/25		
	920/42		

420x185x60 mm



## 1047/240

Slip joint pliers, push button alignment

- Quick, accurate adjustment by pressing push button
- No accidental misadjustment
- Heat-treated jaws

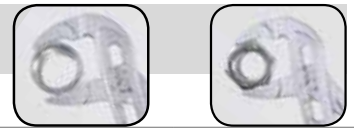

L 240 mm    ∅ Max 36 mm    Max 32 mm

010470240

~~£33,00~~ **£23,00**



## 1048

Slip joint pliers, boxed joints

- slip-proof double layer PVC coated handles

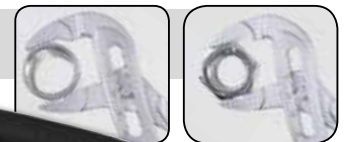

L 250 mm

010480015

~~£29,00~~ **£20,00**



*9-position model*

## 32AU

Automatic centre punches



∅ 3 mm



L 150 mm

000320160

~~£49,00~~ **£34,00**

## 38/B6

Set of 6 drift punches, centre punches, flat chisels and cape chisels, in wallet

30: ∅ 2-3 mm

32: ∅ 4 mm

34: 125-150 mm

36: 150 mm



000380006

~~£53,50~~ **£37,00**



# Drilling and threading tools

## 412/SP19P

Set of 19 twist drills with cylindrical shanks, HSS, entirely ground glossy finishing

R<sub>s</sub> ≤ 700 N/mm<sup>2</sup>  
HV ≈ 750÷820  
Ø 1÷10 x 0,5 mm

115x170x40 mm

004120429

~~£55,00~~ £40,00



## 415CO/SP19A

Set of 19 twist drills with cylindrical shanks, HSS-CO 5%

- For drilling holes into STAINLESS steel, alloy steel, cast iron, mild steel, light alloys

R<sub>s</sub> ≤ 1400 N/mm<sup>2</sup>  
HV ≈ 850÷920  
Ø 1÷10 x 0,5 mm

115x170x40 mm

004150440

~~£110,00~~ £85,00



## 425E/SP3

*new item*

Set of 3 stepped drills, HSS, enhanced grinding efficiency

Ø 4÷12 ; 4÷20 ; 4÷30 mm



004250600

~~£207,00~~ £145,00

## 437U/09

Assortment for repairing damaged threads

M5X0,8  
M6X1,0  
M8X1,25  
M10X1,5  
M12X1,75



004370550

~~£293,00~~ £205,00

370x230x55 mm

## 446/C110

Assortment of 105 chrome-steel taps and dies, metric thread, and 5 accessories for car repair jobs in wooden case

430 M mm	433 M mm	440/440A M mm	441/441A M mm
2x0,4	6x0,75 - 7x0,75	2x0,4	6x0,75 - 7x0,75
3x0,5	8x0,75 - 8x1	3x0,5	8x0,75 - 8x1
4x0,7	9x0,75 - 9x1	4x0,7	9x0,75 - 9x1
5x0,8	10x0,75 - 10x1	5x0,8	10x0,75 - 10x1
6x1	10x1,25 - 11x0,75	6x1	10x1,25 - 11x0,75
7x1	11x1 - 11x1,25	7x1	11x1 - 11x1,25
8x1,25	12x0,75 - 12x1	8x1,25	12x0,75 - 12x1
9x1,25	12x1,25 - 12x1,5	9x1,25	12x1,25 - 12x1,5
10x1,5	14x1 - 14x1,25	10x1,5	14x1 - 14x1,25
11x1,5	14x1,5 - 16x1	11x1,5	14x1,5 - 16x1
12x1,75	16x1,5 - 18x1,5	12x1,75	16x1,5 - 18x1,5
14x2		14x2	
16x2		16x2	

435/0 444/1 436/1  
435/3 444/2



004460060

~~£760,00~~ £532,00

500x337x60 mm

## Patented

### 1128BAX

Double-acting electricians' scissors, with milling profiles in DLC-coated stainless steel



**+ hardness**  
**- coefficient of friction**

#### DLC coating:

DLC (diamond-like carbon) is an innovative carbon-based coating: the high hardness and low coefficient of friction arise from the simultaneous presence of carbon on the surface in the form of graphite, and diamond.

- High blade surface hardness (resistance to abrasion and wear)
- Low coefficient of friction (smoothness and anti-adherence)
- Anti-loose eccentric pin
- With articulated plastic case

011280088

~~£25,00~~ **£17,50**



**Profile and mill:**  
designed to enlarge holes on plastic, from 13 mm to 24 mm.

**Double-acting cutting**  
**- effort + power**

a special cam on the fulcrum reduces of 20% shear stress



### 1770BM

Utility knife with automatic blade locking mechanism, 6 blades

17700050

~~£11,50~~ **£8,00**

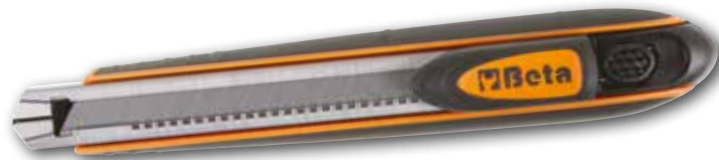

### 1771

Utility knife, 18 mm, supplied with 3 blades

17710000

~~£7,70~~ **£5,00**



### 1778V18

Foldaway knife, aluminium handle in case

017780018

~~£24,50~~ **£17,00**

*new item*



# Measuring tools

## Digital vernier made from hardened stainless steel

- in hard plastic case
- Reading to 0.01 mm
- Screw slider locking
- Mm/inch conversion

DIN 862

UNI EN ISO 13385-1



A Max 150 mm L 225 mm

**1651DGT/150**

016510111

~~£74,00~~ **£52,00**

A Max 200 mm L 285 mm

**1651DGT/200**

016510112

~~£130,00~~ **£91,00**



## 1691BM

Measuring tapes shock-resistant bimaterial ABS casings, steel tapes, precision class: II



	L m	S mm		£	
<b>1691BM/5</b>	5	25	016910205	<del>£7,90</del>	<b>£6,00</b>
<b>1691BM/8</b>	8	32	016910208	<del>£15,50</del>	<b>£11,00</b>
<b>1691BM/10</b>	10	32	016910210	<del>£19,50</del>	<b>£14,00</b>

## 1511

External pullers with two reversible legs

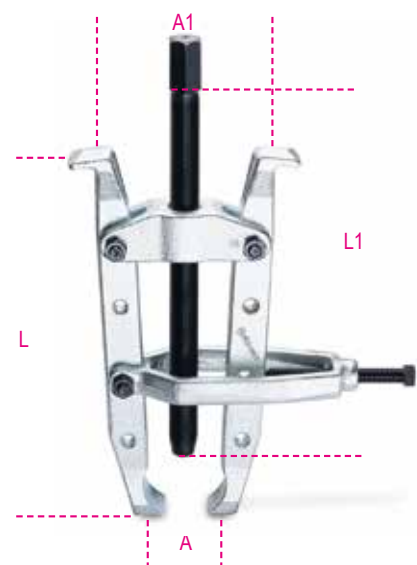

	A min÷Max	L mm	L1 mm	● mm	A1 min÷Max mm	Charge Max kg		£	
<b>1511/1</b>	20÷100 mm	235	230	19	65÷95	5000	015110001	<del>£216,00</del>	<b>£151,00</b>
<b>1511/2</b>	40÷150 mm	330	340	22	103÷190	10000	015110002	<del>£275,00</del>	<b>£192,50</b>
<b>1511/3</b>	40÷150 mm	405	400	22	103÷175	10000	015110003	<del>£325,00</del>	<b>£227,50</b>

# 1500

Two - leg universal puller

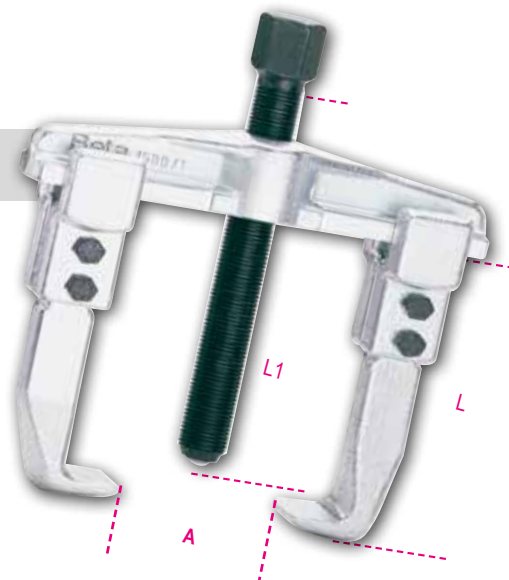
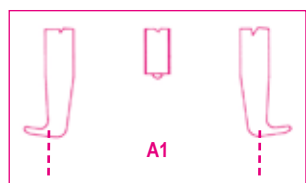

	A min÷Max	L mm	L1 mm	● mm	A1 min÷Max mm	Charge Max kg		£
<b>1500/1</b>	25÷80 mm	100	135	17	70÷130	4500	015000301	<del>£64,00</del> <b>£45,00</b>
<b>1500/2</b>	25÷130 mm	100	135	17	80÷180	4500	015000302	<del>£66,00</del> <b>£46,00</b>
<b>1500/3</b>	50÷160 mm	150	210	22	105÷220	6000	015000303	<del>£113,00</del> <b>£79,00</b>
<b>1500/4</b>	60÷200 mm	150	210	22	120÷270	6000	015000304	<del>£158,00</del> <b>£111,00</b>

# 1428/SB11

Set of pullers for damaged nuts square drive with support

**36"** 8-10-11-12-13-14 mm    **12"** 15-16-17-18-19 mm



014280111

~~£213,00~~ **£149,00**

# 1547/C6

Dummy ball bearing extractors

• quick, safe extraction



Bearings  
**1547/1**  
 6011-6014, 6206-6211, 6303-6308, 6403-6405  
**1547/2**  
 6004-6010, 6200-6205, 6300-6304

420x185x60 mm



015470006

~~£212,00~~ **£148,00**



## 1430/S8

Set of 8 tapered extractors for broken screws and studs, made from hardened steel (item 1430/..), in case

014300108

~~£67,50~~ £47,00



1430/1-1430/2-1430/3  
1430/4-1430/5-1430/6  
1430/7-1430/8

## 1529/C7

*new item*

Pulley puller

Kit contents:

- 2 legs with two 4.7-mm-thick feet
- 2 legs with one 4.3-mm-thick foot
- 1 leg with two 2.3-mm-thick feet
- 1 leg with one 2.3-mm-thick foot

The pair of legs can be made up according to one's operating requirements

015290100

~~£132,00~~ £91,00



285x155x50 mm

## 1457/B4

*new item*

Tool set for releasing Rilsan hose fittings

Sizes included in set:

- 6x8
- 10x12
- 15x16
- 18x1/2



014570024

~~£40,50~~ £28,00



## 3003

Creeper made of shockproof plastic



Ø castors: 76 mm

030030001

~~£67,00~~ £47,00

120 mm

## 334

Pipe cutter for copper and light alloy pipes

003340001

~~£24,50~~ £17,00



Ø 3÷30 mm  
1/8"÷1"1/8

## 351C

Pipe cutter and tube flaring tool in plastic case



351P Ø 4-4,75-6-8-10-12-14 mm

003510010

~~£113,00~~ £79,00



225x150x45 mm



334 Ø 3÷30 mm  
1/8"÷1"1/8



350 Ø 4÷14 mm

## 342

Ratchet-type shears for plastic pipes

003420030

~~£41,00~~ £29,00



Ø 0÷42 mm  
1"5/8

## 345C

*new item*

Multilayer pipe gauge

003450032

~~£36,50~~ £26,00



# General maintenance tools

## 1149F

Front wire stripping pliers  
with cutting blade, self-adjusting

011490010

~~£15,00~~

£10,50



  
0,2÷6 mm<sup>2</sup>

## 1741B

Riveting pliers supplied  
with 4 interchangeable nozzles

017410000

~~£35,00~~

£25,00



## 1741U

Ultra compact riveting pliers  
with adjustable force  
with 4 interchangeable nozzles

017410450

~~£39,00~~

£27,00



3 legs: enhanced rivet  
hold



# General maintenance tools

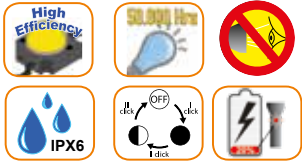

*anodized aluminium*

**1350 LUMEN**  
**1834P XL**  
 018340330  
~~£83,00~~ **£58,00**  
 3xD Not included

**500 LUMEN**  
**1834P L**  
 018340325  
~~£66,00~~ **£46,00**  
 1xAA 2xAA 3xAA Not included

High-brightness LED torch, made of sturdy,

**350 LUMEN**  
**1834P M**  
 018340320  
~~£39,50~~ **£28,00**  
 1xAAA 2xAAA 3xAAA Not included

**300 LUMEN**  
**1834P S**  
 018340310  
~~£32,50~~ **£23,00**  
 2xAA Not included

## 1838SLR

CE *new item*

Rechargeable, articulated LED inspection lamp

- Compact front LED (200 lumens) and head LED (100 lumens) for inspections
- Lighting body no more than 9 mm thick
- Operating range: 5/2.5 hours (depending on light level setting)
- With USB charger
- With metal hook and magnet
- IP80



*Ultrathin*  
*Compact and versatile*



242x41x30mm

018380201  
~~£96,00~~ **£67,00**

## 1837N



Magnetic, articulated lamp with high-brightness LEDs, up to 400 lumen

- Batteries (not included) :  
 - 1xAA (life 20/60 h)  
 - 2xAA (life 28/84 h)w  
 - 3xAA (life 36/108 h)
- Lumens: 400>40>OFF
- Charge indicator
- Adjustable focus
- IPX6

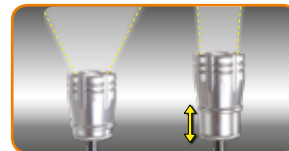
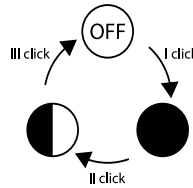

018370002  
~~£73,50~~ **£51,00**



# Pneumatic tools



## 1927P

### Reversible impact wrench, made from composite material

- Lightweight and well-balanced for enhanced ease of use
- Reversible lever
- Three power adjustable screwing positions
- Exhaust through handle
- Vibration-dumping handle

019270008

~~£397,00~~ £278,00

Extremely powerful 1750 Nm

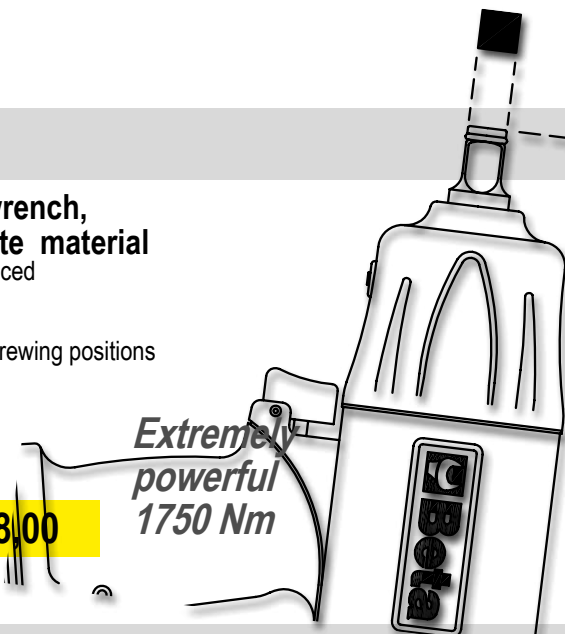

1/2"

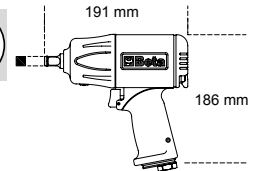

Free speed	rpm	7.500
Impulse device		Double hammer
Maximum torque	Nm	1750
Bolt capacity	Cl 8.8	M24●36 mm
Bolt capacity	Cl 12.9	M20●30 mm
Air inlet	GAS	1/4"
Working pressure	Bar	6,2
Internal hose size (Ø)	mm	10
Mean air consumption	l/min	290
Weight	kg	2



## 1927XM/K5

### Assortment of one compact reversible impact wrench and five impact sockets, in plastic case

- Single hammer impulse device
- Amazingly compact and powerful
- One-hand reverse button
- Three power adjustable screwing/unscrewing positions
- Exhaust through handle
- Balancing hook

720 17-19-21-22-24 mm

019270129

307x206x86 mm

~~£298,00~~ £191,00



1/2"

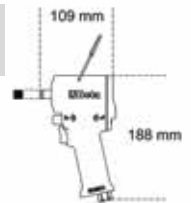

Ultra compact and powerful 770 Nm

Free speed	rpm	10.000
Impulse device		Single hammer
Max. torque	Nm	770
Bolt capacity	Cl 8.8	M22●34 mm
Bolt capacity	Cl 12.9	M18●27 mm
Air inlet	GAS	1/4"
Operating pressure	bar	6,2
Internal hose size (Ø)	mm	10
Mean air consumption	l/min	122
Weight	kg	1,3



## 1927CD/K3

### Assortment of one reversible impact wrench and three impact sockets

- Double hammer impulse device
- Lightweight and well-balanced for enhanced ease of use
- High torque
- Reversible lever
- Three power adjustable screwing positions
- Exhaust through handle
- Silenced

019270107

350x305x86 mm

~~£387,00~~ £248,50



1/2"

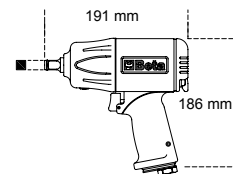

Free speed	rpm	7.000
Impulse device		Double hammer
Maximum torque	Nm	1020
Bolt capacity	Cl 8.8	M22●34 mm
Bolt capacity	Cl 12.9	M18●27 mm
Air inlet	GAS	1/4"
Working pressure	bar	6,2
Internal hose size (Ø)	mm	10
Mean air consumption	l/min	130
Weight	kg	1,9

## 720S/SB6

1/2"

New item

Set of 6 impact sockets, compact series, 1/2" female drive, with hanging slide

13-15-17-19-22-24 mm

007200906

~~£45,00~~ £30,00



28 mm



## 1928K4

### Assortment of one reversible impact wrench and four impact sockets, long series

- Extremely powerful in its category
- Reversible lever
- Three power adjustable screwing positions
- Balancing hook

728L 27-30-32-36 mm

019280104

~~£625,00~~ £437,50

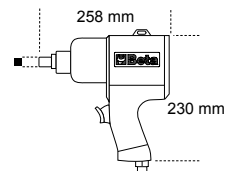

410x330x106 mm

Free speed	rpm	4.000
Impulse device		Pin Clutch
Maximum torque	Nm	<b>1.493</b>
Bolt capacity	Cl 8.8	M27●41 mm
Bolt capacity	Cl 12.9	M24●36 mm
Air inlet	GAS	3/8"
Working pressure	bar	6,2
Internal hose size (Ø)	mm	10
Mean air consumption	l/min	260
Weight	kg	5,2



## 1928DA

### Reversible impact wrench

- Double hammer impulse device
- Sturdy and compact; high torque
- Reversible lever
- Three power adjustable positions
- Exhaust through handle
- Slip-proof ergonomic handle

019280022

~~£615,00~~ £430,50

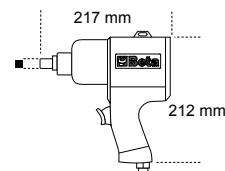

Free speed	rpm	5.000
Impulse device		Double hammer
Max. torque	Nm	<b>1.695</b>
Bolt capacity	Cl 8.8	M27●41 mm
Bolt capacity	Cl 12.9	M24●36 mm
Air inlet	GAS	3/8"
Working pressure	bar	6,2
Internal hose size (Ø)	mm	10
Mean air consumption	l/min	210
Weight	kg	4,3



## 1928CD

### Reversible impact wrench, made from composite material

- Double hammer impulse device
- High weight/power ratio
- Reversible lever
- Three power adjustable screwing positions
- Exhaust through handle
- Silenced

019280007

~~£820,00~~ £574,00

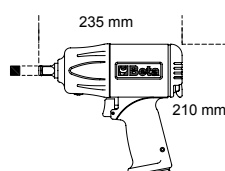

Free speed	rpm	4.500
Impulse device		Double hammer
Maximum torque	Nm	<b>1.800</b>
Bolt capacity	Cl 8.8	M27●41 mm
Bolt capacity	Cl 12.9	M24●36 mm
Air inlet	GAS	3/8"
Working pressure	bar	6,2
Internal hose size (Ø)	mm	10
Mean air consumption	l/min	215
Weight	kg	3,5

# Pneumatic tools



## 1930PA

1"



### Reversible impact wrench

- Extremely lightweight and compact
- Auxiliary handle
- Reversible lever
- Three power adjustable positions

019300032

~~£865,00~~

**£605,50**

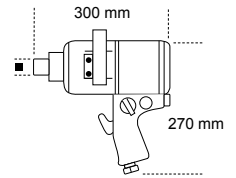

Free speed	rpm	3.500
Impulse device		Double hammer
Maximum torque	Nm	<b>2445</b>
Bolt capacity	Cl 8.8	M36●55mm
Bolt capacity	Cl 12.9	M30●46mm
Air inlet	GAS	1/2"
Working pressure	bar	6,2
Internal hose size (Ø)	mm	13
Mean air consumption	l/min	350
Weight	kg	9,6



## 1930HLA

1"



### Reversible impact wrench

- Double hammer impulse device
- 9" long anvil
- Auxiliary handle
- Reversible lever
- Three power adjustable screwing positions
- Upper exhaust

019300040

~~£1.570,00~~

**£1.099,00**



Free speed	rpm	3.000
Impulse device		Double hammer
Maximum torque	Nm	<b>3661</b>
Bolt capacity	Cl 8.8	M42●65mm
Bolt capacity	Cl 12.9	M33●50mm
Air inlet	GAS	1/2"
Working pressure	bar	6,2
Internal hose size (Ø)	mm	13
Mean air consumption	l/min	460
Weight	kg	16,4

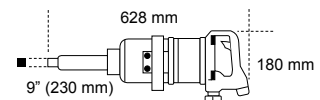

## 1930ZL

1 1/2"



### Reversible impact wrench

- Double hammer impulse device
- Auxiliary handle
- Reversible lever
- Three power adjustable screwing positions
- Upper exhaust

019300070

~~£2.040,00~~

**£1.428,00**



Free speed	rpm	3.000
Impulse device		Double hammer
Max. torque	Nm	<b>4.068</b>
Bolt capacity	Cl 8.8	M42●65 mm
Bolt capacity	Cl 12.9	M36●55 mm
Air inlet	GAS	1/2"
Working pressure	bar	6,2
Internal hose size (Ø)	mm	13
Mean air consumption	l/min	480
Weight	kg	15

**High torque 4068 Nm**

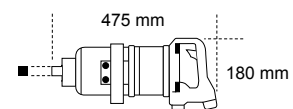



Beta Tools (UK) Limited  
Unit D - Horton Enterprise Park  
Hortonwood 50, Telford  
Shropshire, TF1 7GZ  
Sales: Tel. (01952) 677977

*[www.beta-tools.co.uk](http://www.beta-tools.co.uk)*  
*[sales@beta-tools.co.uk](mailto:sales@beta-tools.co.uk)*

**Promotion valid until 31.03.2018** subject to availability

The images are for reference only. Beta Utensili S.p.A. reserves the right to update and upgrade its product range without notice.